

You should have received the following:

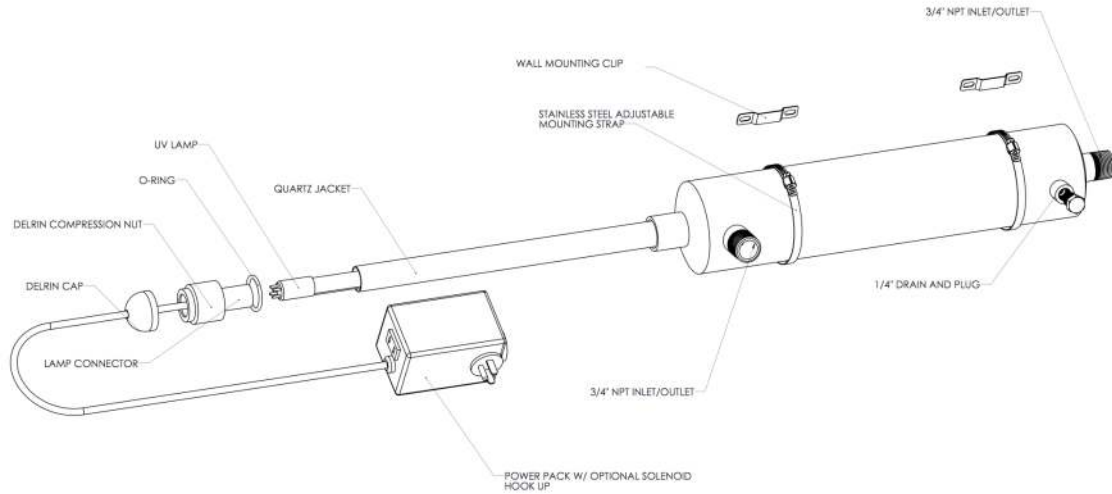

REPLACEMENT PARTS LIST

MODEL	Lamp #	Quartz #	Ballast #	Orings	Compression Fittings
GUV-7	#1 L-501414	#1 Q-532017	#1 P-78PIBP	#1 M-75214O	#1 M-001RCN
GUV-10	#1 L-524414	#1 Q-532017	#1 E-40HOIB	#1 M-75214O	#1 M-001RCN
GUV-15	#1 L-050433	#1 Q-521035	#1 E-361GUB	#1 M-75214O	#1 M-001RCN
GUV-20	#1 L-024433	#1 Q-521035	#1 E-33120B	#1 M-75214O	#1 M-001RCN

1. Your Disinfection Unit – Pre-Installation

Your Ultraviolet (UV) water disinfection system has been tested at Glasco’s manufacturing facility. The unit has been hydrostatically pressure-tested to 100 psi. In some cases, a small amount of water may remain in the vessel. In order to insure that the unit works at optimum performance, please follow the instructions outlined in this manual.

1.1. Warning

UV light is harmful to your eyes and skin. Do not look directly into the light. Always unplug (disconnect power) your unit before installing or removing a lamp. Your unit may have a green LED light that indicates that the lamp is operating and the unit has an audible alarm that will sound in the event of lamp failure. If the LED goes out, contact your dealer for service. If your unit has an audible alarm and it goes off, contact your dealer.

Since the unit is run by electricity, please remember to disconnect all power before servicing the equipment. Failure to do so may result in serious injury or death.

When handling lamps and quartz, use gloves to prevent them from becoming dirty. If they do, wipe them with alcohol.

1.2. Your Water Supply

Glasco recommends that trained professionals test and maintain your water supply. In addition to testing the water to see if UV is appropriate, we recommend pre-filtering systems (softeners, carbon or reverse osmosis) to help remove tastes, odors, minerals and cysts.

1.3. UV Effectiveness

Your disinfection unit needs to be maintained. Change your lamp on a yearly basis and insure that the quartz sleeve is cleaned on a regular basis.

Failure to do periodic maintenance will impact your unit's effectiveness.

1.4. Flow Rate

Your unit has been designed to accommodate a certain flow rate. In order to work effectively, you may need to install a flow control device. This device attaches to the inlet and controls the water that enters the system. Note: your system may have come with a flow controller.

Failure to use a flow control (available at most plumbing supply stores) may reduce the effectiveness of your disinfection unit.

1.5. Inspection

Insure that lamps and quartz have not been broken. We recommend that you use gloves when handling lamps and quartz sleeves to prevent them from becoming dirty. Dirt and skin oils will impact the UV output.



A warranty sheet has been included. Please fill out the warranty and send back to manufacturer or dealer. This warrantees the chamber for 7 years and electrical components for 1-year.

1.6. Electrical Requirements

The electronics have been designed to work with standard power supplies. Since the unit is susceptible to power fluctuations, we recommend that the system be kept off any lines where there are surges. This includes pumps or motors. If there are fluctuations, please use a surge suppressor. Systems will come with plugs, which require no "hard wiring". Please look at the outside of the electrical "box" for Voltage, Cycle and AMP draw.

1.7. Location of Unit

UV disinfection works best when it is installed closest to point of use. When installing, remember that you will need to be able to remove lamps and quartz as part of a maintenance schedule. Allow yourself enough room to accomplish these tasks. Unit can be mounted vertically or horizontally. Inlet and outlet can face up or down.

Step	Action	Diagram
1	<p>Use # 10 screws (not included) to mount clips (M-2500MC) to wall.</p> <p>Note: On GUV-15/20 four mounting clips are included. Two clips are to be mounted two inches apart, and the remaining clips are to be mounted directly below them 2" apart.</p>	
2	<p>Open the worm gear clamps (M-0203WC) completely and then thread through mounting clips (M-2500MC).</p> <p>Note: On GUV-15/20 thread worm gear clamp (M-0203WC) through both mounting clips that are installed parallel to each other.</p>	
3	<p>Tighten worm gear clamps (M-0203WC) over UV unit until snug.</p>	

4	UV unit may be mounted vertically or horizontally. UV units inlet port may be rotated 180 degrees. If your system has been modified with a port do not install with the port facing down.	
---	---	---

2. Your Disinfection Unit – Installation

If you are attempting to install the unit by yourself and you have questions, please call your water quality or plumbing professional. Improper installation can cause potential water damage to your property and can also reduce the effectiveness of the UV disinfection system.

2.1. Recommended Supplies

Before getting started, you will need the following:

- Screws to bolt the unit into place
- Teflon tape to insure quality sealing
- Shutoff valves for both the inlet and outlet
- Unions before and after the unit
- Flow control (from dealer or plumbing supply house) Note: many units come with this as a standard accessory. It looks like a brass disk with a rubber insert. This will be press fit into the inlet and outlet.

2.2. Plumbing

Your unit may be installed under the sink or where the water enters the building. In either case, we recommend that shutoff valves be installed before the inlet and after the outlet. This allows for easier yearly servicing and allows you to shut off the water supply if you have a problem with the unit.

A damaged quartz sleeve can cause a potential leaking problem. An unchecked leak can lead to severe flooding.

2.3. Quartz for Close-ended Units (creating a watertight unit)

A sealed unit has one opening for the lamp and quartz to go into. The quartz has a dome on one end like a test tube.

Once the unit has been secured and the piping connections have been made, it is time to install the quartz sleeve.

The unit will have come with a compression nut that is in place and holds an O-ring. Remove the nut and the O-ring.

Insert the dome end of the quartz into the unit. Guide the quartz through the unit until it rests at the end in a spring.

Once in the spring, you can screw in the compression nut (make sure that the O-ring is properly positioned in the nut). Create a tight seal, but not too tight as you may crack the quartz sleeve.

Now that it is in place, you can test the unit to see if it is watertight. Slowly pressurize the unit by allowing water to run through the unit for five minutes. As this is happening, check to see if the seal is dry. If it is not, you will need to redo the seal. If it is dry, you are prepared to install the lamp.

2.4 Installing the Lamp

Carefully slide the lamp into the quartz (dropping the lamp can break the quartz). Once it is in place, connect the lamp to the socket. When you have done that, tighten the cap to the nut and then plug in the unit.

3. Maintenance

As noted in this manual, your lamp needs to be replaced on a yearly basis the quartz cleaned on a more frequent basis.

The quartz may have “build up” on it. If it does, clean it with soap and water. If the quartz is stained, use a product like CLR or LimeAway (both available at the grocery store).

When you remove the quartz, please follow the same instructions as above.

Track your maintenance record on the front page of this manual.

4. Operation Status and Alarms - Basic

The unit will have come with an audible and or visual lamp status alarm. In the event of a lamp out, the audible alarm will sound. If the unit has a visual alarm (Green light aka LED indicates lamp is on), the LED will go off when the lamp goes off. If this is the case, have your water professional check to see if the lamp needs to be replaced. When alarming, the water may not be safe to drink.

If the lamp is working, suspect that the alarm board has been damaged and is in need of repair.

If you have to access the BCC (Ballast control center) loosen the strain relief on the power cord and pull the base of the box towards the lamp harness.

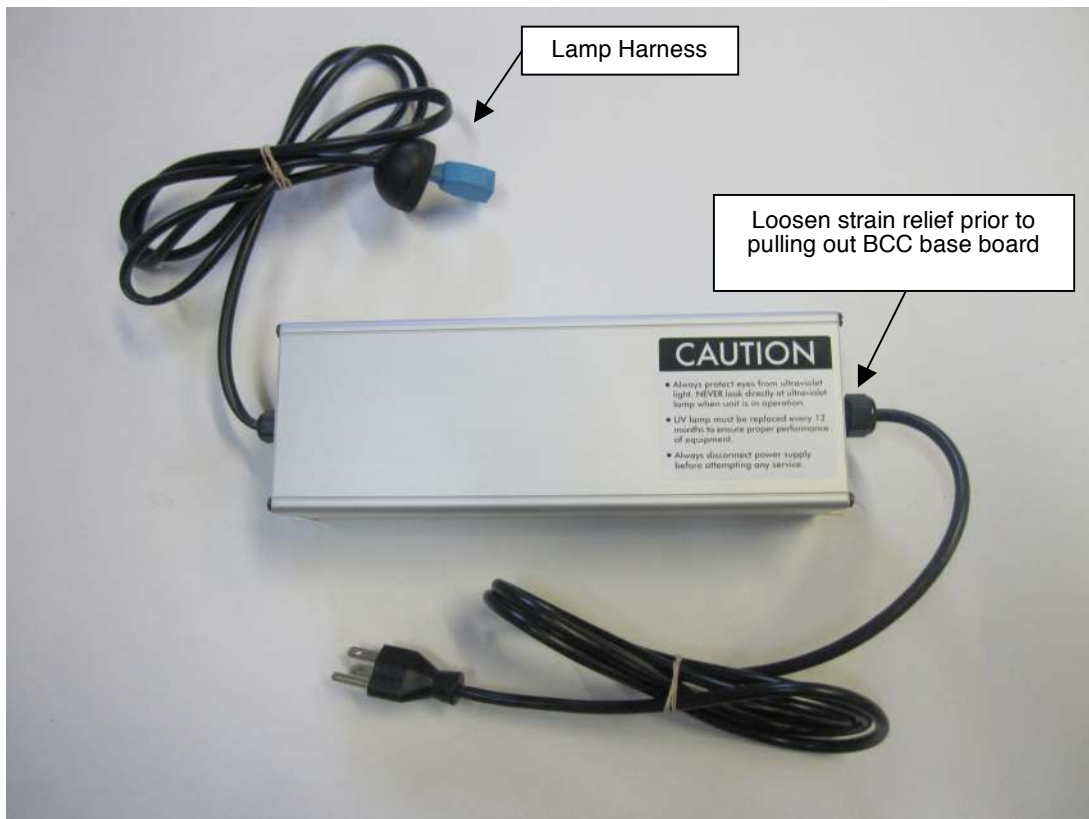

GUV-10, GUV-15, GUV-20 BCC

5. Recommendations

- Use a licensed plumber or qualified water professional to do the installation.
- Check the unit on a regular basis to see if the lamp is on (the green LED indicator will tell you if the lamp is working).
- When first installing the unit, you will need to make sure that all plumbing after the unit has been sanitized. This will make sure that all microorganisms have been destroyed. Plumbers often fill the UV chamber with disinfectant and flush out the pipes. They do this by opening all spigots and allowing the disinfectant to run its course through the pipes. Professionals should do this because many disinfectants can be harmful or fatal if swallowed.
- Install carbon filters, softeners and reverse osmosis systems BEFORE the UV system. These types of filters can breed microorganisms.
- Use a flow control device that is rated for your unit's GPM flow rate.

6. Options

Your system may have come with optional equipment. If it did, instructions for these options are attached.

Automatic Shut-off Valve aka Normally Closed Solenoid

Your system may have come with an optional automatic solenoid valve.

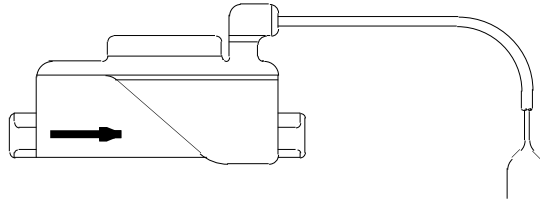

This device will stop the water flow if the UV lamp goes out or if the UV intensity falls. It is considered a “normally closed” valve. This means that when there is no power to it, it closes. This will occur during a power outage or lamp failure.

The solenoid will work off of a signal from the ballast, which indicates lamp out. If lamp fails, then the solenoid will shut off the water supply.

The solenoid will also work off of a signal from the UV monitor, when the UV intensity has fallen to an unsafe level. In the event of water stoppage, you will need to correct the problems.

Reasons for stoppage include: Power failure, Lamp is out, Ballast is out, UV lamp is failing, Solenoid is damaged

There is a manual override on some of the valves. Call your water professional in case of an emergency. The manual valve is a white toggle switch. In order to open the valve, it must have power. This is generally provided by the UV system, but in emergencies, power can be brought directly to the valve.

The main power box control will have leads for attaching the solenoid. These leads will need to be connected to the leads on the actual solenoid valve. The solenoid will have come with connectors.

The solenoid valve will have an arrow on it indicating flow direction. Please install it the solenoid so that the path of the water goes with the arrow.

Manual Quartz Cleaning System

Your system may have come with an optional manual quartz cleaning system. This device will allow you to clean the quartz sleeve without having to disassemble the disinfection chamber.

! WARNING ! The plunger may be forced out when water pressure builds up. When installing the unit, make sure that you stand clear of the plunger when pressurizing the system.

In order for the system to work at optimum performance, you must clean the quartz on a periodic basis. To clean quartz, pull the plunger toward you and then push it in again. Do this a few times a month.

You may need to change the o-rings on the wiper on a periodic basis. Please open the system once a year to inspect the quartz and the wiper rings.

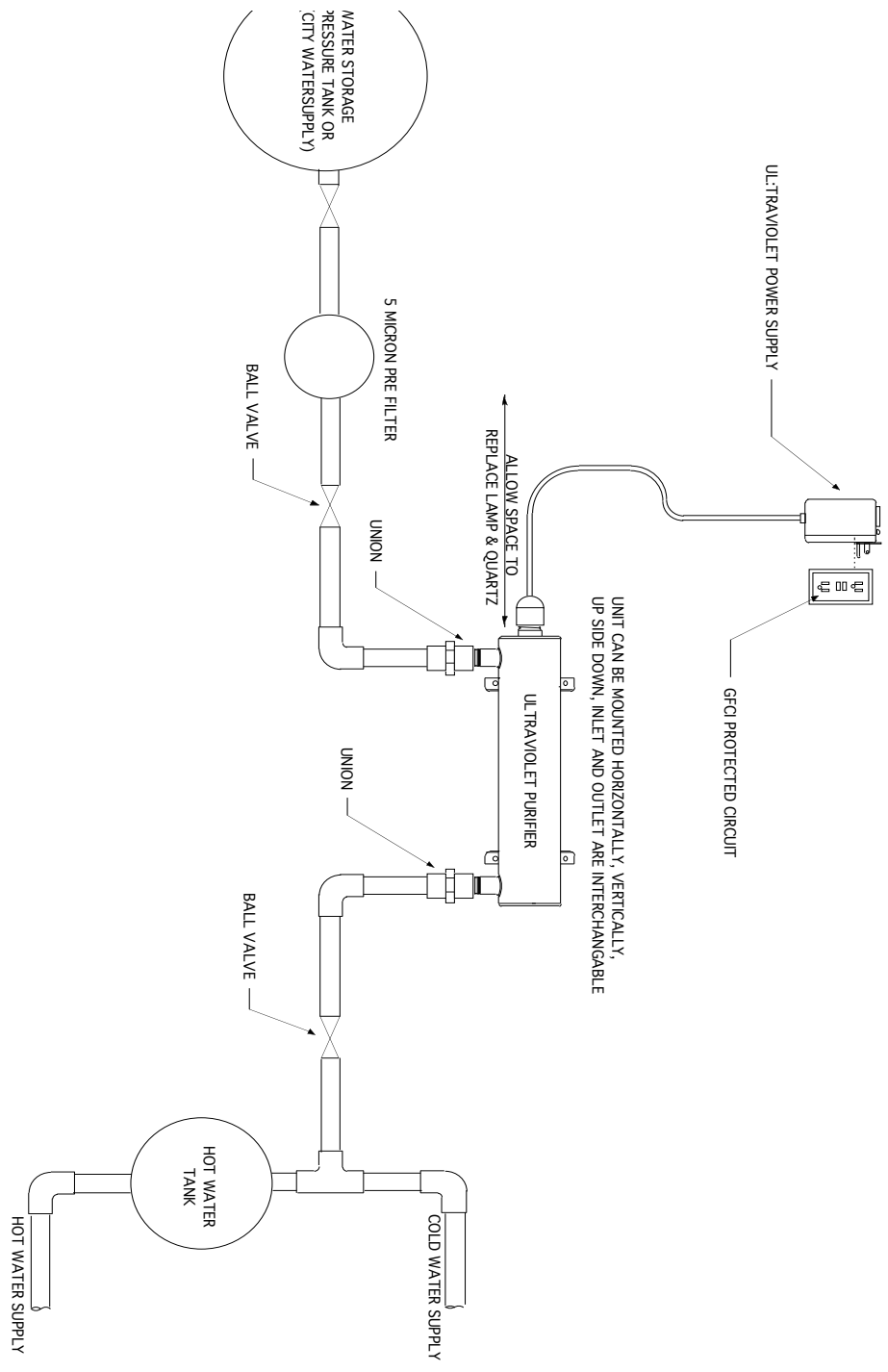

WARRANTY REGISTRATION

MODEL NUMBER/TYPE: _____

DEALER NAME: _____

PURCHASE DATE: _____

NAME: _____

ADDRESS: _____

CITY: _____ STATE: _____ POSTAL CODE: _____

COUNTRY: _____

PHONE: _____ EMAIL: _____

Please fill out the above information and forward it to your dealer or to Glasco UV LLC. This will provide you with a 7-year warranty on the stainless steel chamber and a 1-year warranty on the electrical components. UV lamps are warranted for 30 days. After the initial 30 days of operation, replacement or refund will be pro-rated based on the expected lamp life of 9,000 hours.

In addition, this will allow your dealer to remind you when it is time to replace your lamp and quartz.

This warranty applies to equipment that has been installed and maintained according to the instructions in this manual. Glasco UV LLC is not responsible for damage due to improper use, operation or installation.

This warranty needs to be received by Glasco UV LLC within 25 days of initial operation. The warranty applies to replacing defective equipment.

Glasco shall have no liability hereunder, either direct or contingent, for any consequential damages. Glasco recommends that you use pre-filters, flow-control devices and inspect the lamp to insure that it is functioning.



31 Industrial Avenue, Ste #3
Mahwah, NJ 07430
(201) 934-3348 Fax (201) 934.3388